

Inground option

WARNING:

It's essential to keep a minimum clearance access of **700mm** all around.

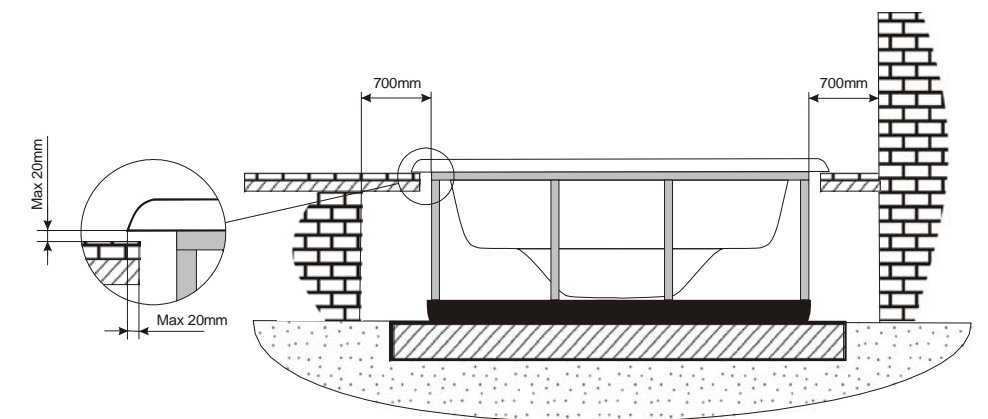

↑
ELECTRICAL BOARD CONNECTIONS ACCESS
↑

According to our policy of continuous improvement, dimensions, features or components of this product can be partially or completely changed without prior notice.
It's Customer responsibility to verify that this is the last version of the drawing

04	15/10/2014	I.Pozo	New spare template
03	15/05/2014	I.Pozo	Drawing update
02	07/01/2013	I.Pozo	Drawing update
01	18/02/2009	M.Freixes	Update log
00	26/01/2009	M.Freixes	Drawing creation
Change No.	Date	Name	Modification

Remarks			COMMERCIAL			
Dimensions in mm. General Tolerances +/- 10mm						
Drawn	26/01/2009	M.Freixes		Part Number 43930	Rev. 04	First Angle Projection
Checked	26/01/2009	I.Nicolas				
Scale	1:15					
Sheet	1/2					
General Tolerance DIN 7168 ISO 2768g						

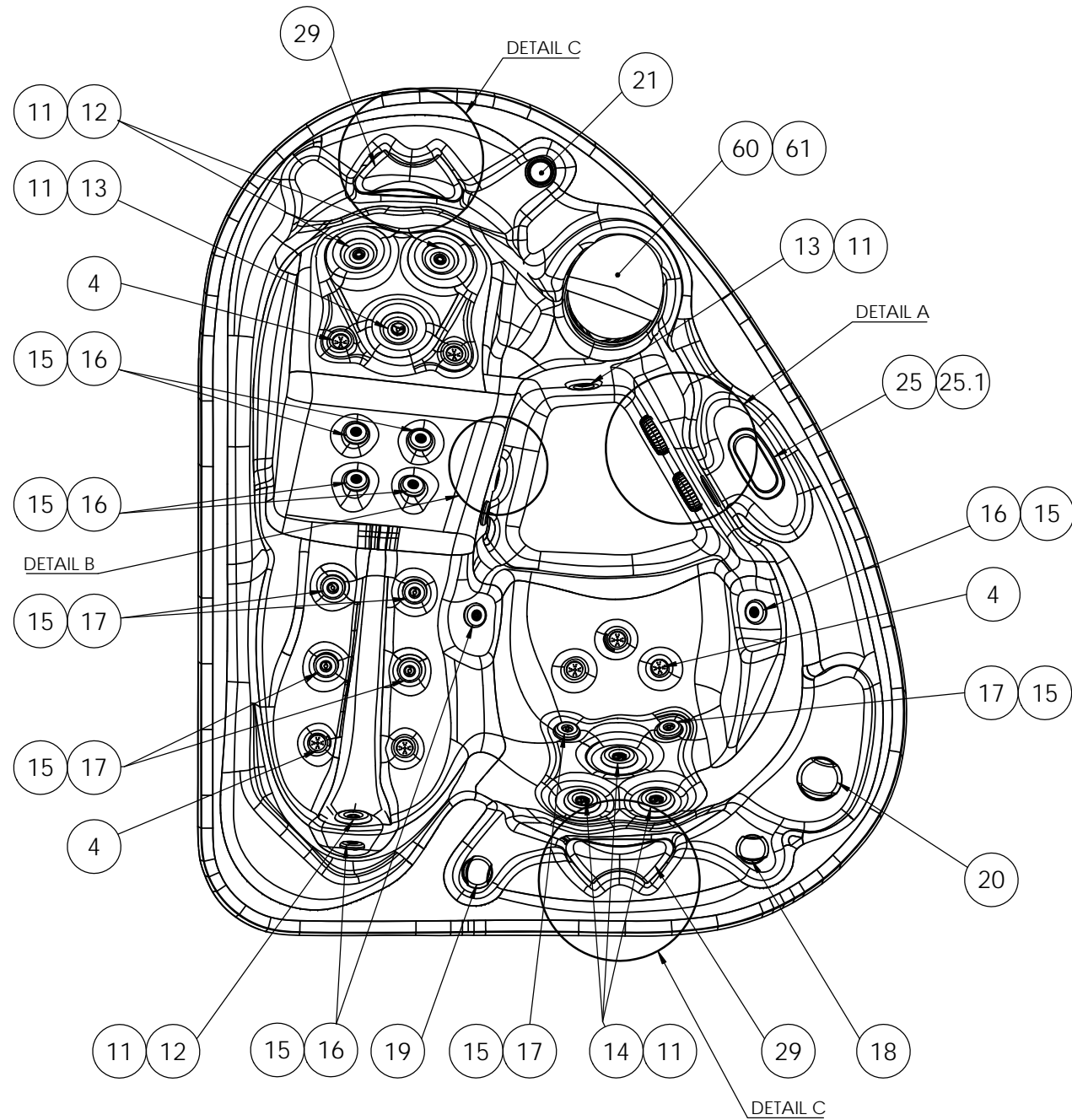

PUMPS SPARE CODES

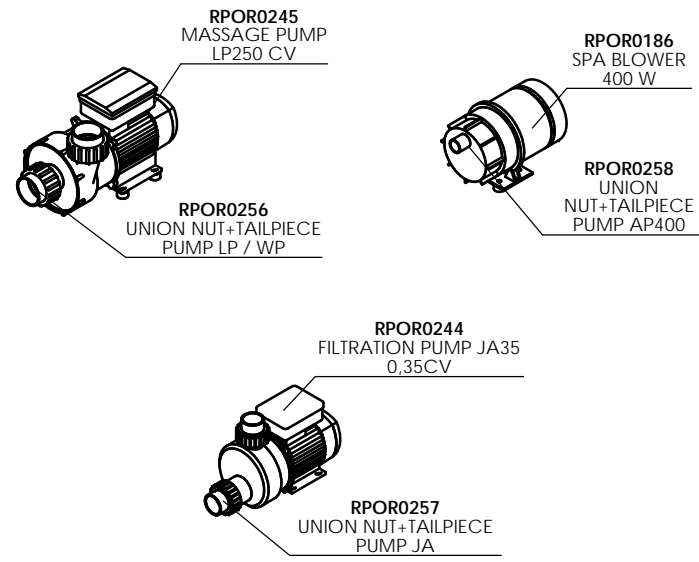

HEATER AND DESINFECTATION SPARE CODES

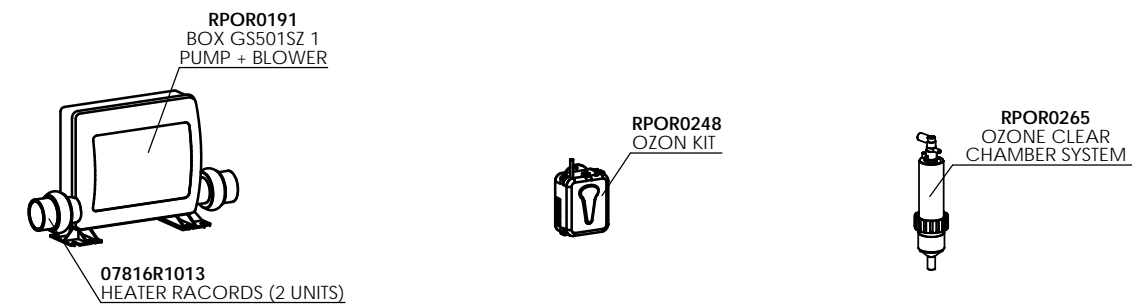

07816R1013 HEATER RACORDS (2 UNITS)
 RPOR0101 - TEMPERATURE PROBES GS I GL (x 2)
 RPOR0105 - HEATER 3 KW GS I GL
 RPOR0197 - DIGITAL PANEL GS501SZ

RPOR0136 DRAIN FILL VALVE (BLACK)

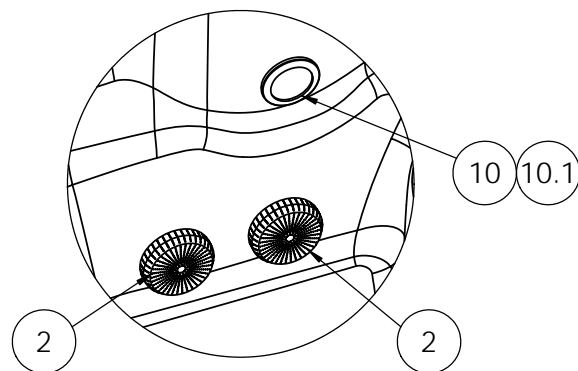

A (1 : 10)

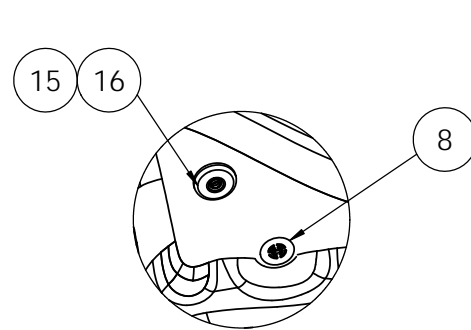

B (1 : 10)

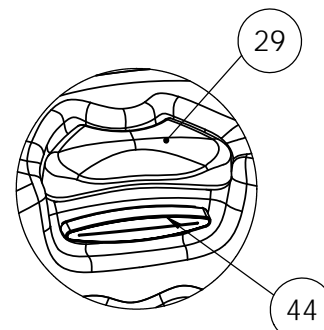

C (1 : 10)

ACCESSORIES			
Position Num.	Part Nº SPARE	Description SPARE	Quant.
2	RPOR0225	GREY SPA DRAIN 2" ADAPTOR SOCKET D.50	2
4	REMP0046	WHITE-STAINLESS STEEL AIR NOZZLE	7
8	RPOR0003	GREY DRAIN SET - BODY+COVER+ASSEMBLY	1
10	RPOR0239	SPOTLIGHT LED SET RD	1
10.1	RPOR0240	MASTER LED LIGHT	1
11	RPOR0236	JET BODY SET RD 3"	8
12	RPOR0231	FRONTAL JET 3" STAINLESS STEEL DIRECTIONAL	3
13	RPOR0232	FRONTAL JET 3" STAINLESS STEEL 1 JET ROTO	2
14	RPOR0233	FRONTAL JET 3" STAINLESS STEEL TWIN ROTO	3
15	RPOR0235	JET BODY SET RD 2"	14
16	RPOR0230	FRONTAL JET 2" STAINLESS STEEL DIRECTIONAL	8
17	RPOR0260	JET TWIN ROTO 2" INOX	6
18	RPOR0261	VENTURY CONTROLLER SS	1
19	RPOR0263	VALVE ON-OFF 1" SS	1
20	RPOR0262	3 WAYS SS VALVE 2"	1
21	RPOR0264	AROMA DISPENSER ASM LIT	1
25	RPOR0241	CONTROL PANEL VL600S	1
25.1	RPOR0243	COVER DIGITAL PANEL VL600S MASSAGE + BLOWER	1
29	RPOR0095	SMALL HEADREST - PACIFIC-ANTARTIC	2
44	RPOR0278	SS 7" WATERFALL	2
49	RPOR0136	DRAIN FILL VALVE (BLACK)	1
60	32473R0004	TAPA SKIMMER	1
61	RPOR0183	CARTRIDGE FILTER	1

According to our policy of continuous improvement, dimensions, features or components of this product can be partially or completely changed without prior notice. It's Customer responsibility to verify that this is the last version of the drawing

Change No.	Date	Name	Modification
04	15/10/2014	I.Pozo	New spare template
03	15/05/2014	I.Pozo	Drawing update
02	07/01/2013	I.Pozo	Drawing update
01	18/02/2009	M.Freixes	Update log
00	26/01/2009	M.Freixes	Drawing creation

Remarks Dimensions in mm. General Tolerances +/- 10mm			SPARE PARTS DRAWING		
Drawn	26/01/2009	M.Freixes			
Checked	26/01/2009	I.Nicolas	IBERSPA	Part Number	43930
Scale	1:15	General Tolerance DIN 7168 ISO 2768g		Rev.	04
Sheet	2/2			First Angle Projection	

Property of IBERSPA S.L. Avda. Pla d'Urgell 2-8 25200 Cervera, Spain. Don't use without permission. Keep this information confidential and use it solely for the permitted purpose.